

REW by Rafa García, 2014

Sistema de asientos para descansar, comer o trabajar / Sofa system for Resting, Eating or Working / Canape pour se reposer, manger ou travailler



new

new

EXPLICACION DEL MODELO

REW es el acrónimo de rest-eat-work (descansar-comer-trabajar).

Una versátil creación de **Rafa García**. El significado literal de esas palabras define a la perfección la funcionalidad del programa de asientos **REW**.

Rest. El descanso lo proporciona una familia de sillones, sofás y módulos tan ligeros como confortables en los que podremos elegir entre dos diseños diferentes para los brazos: uno tan alto y delgado como el respaldo y otro más bajo y mullido como la base del asiento.

Eat. La parte "nutritiva" se corresponde con un amplio abanico de bancadas para acompañar todo tipo de mesas de comedor. Las bancadas están disponibles con dos fondos (57 y 72 centímetros). El fondo más corto encaja con el prototipo tradicional de bancada y proporciona una sentada más firme y recta. Además, la terminación en esquina de los brazos altos permite realizar composiciones con ángulos rectos. El fondo más largo tiene una medida ideal para llenarlo de cojines de decoración y generar una sentada más informal, perfecta para largas sobremesas.

Work. La productividad en el trabajo está directamente relacionada con nuestra concentración y bienestar. La versión de sillones, sofás y módulos con respaldo alto permite gozar de cierto aislamiento en medio de una gran oficina o el hall de hotel.

Rafa también ha diseñado dos cojines para completar el programa.

Las patas son de acero epoxi negro y madera de fresno, las cuales se pueden solicitar en todos los colores de nuestra carta de tintes.

Opcionalmente, es posible incorporar un kit de conector USB-A+C y enchufe con una amplia variedad de clavijas. En cada referencia de la tarifa tiene indicadas opciones disponibles. La clavija de conexión a la red eléctrica viene definida por el enchufe internacional seleccionado.

NUOVO REW

Como novedad llega la **Bancada XXL**, que se caracteriza por estar a medio camino entre la bancada y el sofá. Con altura de asiento propia de una bancada cuenta sin embargo con una sola almohada tanto de asiento como respaldo que aporta un nivel de confort extra. Además, el brazo ha acertado su longitud para facilitar su acceso.

Las **REW ROOM** permiten distribuir el espacio creando pequeñas "salas". Las composiciones con sofás sirven tanto para crear cómodos reservados en bares y cafés, como espacios de reunión informales en grandes oficinas, mientras que las composiciones con bancadas XXL son la mejor manera de configurar espacios privados en restaurantes. Y todo ello sin necesidad de obra alguna.

DESCRIPTION

REW is an acronym for rest-eat-work.

This creation by **Rafa García** is tremendously versatile, and can be used for a variety of diverse projects that require pieces for resting, eating or working.

Rest. An entire family of chairs, sofas and modules, as light as they are comfortable, can be used with two different types of arm: one is high and thin like the back and the other is low and soft, like the base of the design.

Eat. The "nutritious" part corresponds to an ample number of benches which can be used with a dining table. The benches are available in two depths. The shallow version is the archetypal dining bench, providing a firm, upright sitting position. Moreover, the finish of the arms in a corner permits compositions with angles to be made. The deep version is ideal to fill with scatter cushions and create an informal environment, perfect for long postprandial conversations.

Work. The productivity at work is directly related to our concentration and feeling of wellbeing. These versions of the sofas, modules, and chairs enable a certain degree of privacy in an office setting, or the hall of a hotel.

Rafa has also designed a couple of cushions to complete the programme.

The feet are black epoxy coated steel and ash, which can be stained to any of the colours in our collection.

A optional USB-A+C and AC socket is available. Each reference on the price list indicates the options that are available. The plug for the kit is defined by the type of AC socket selected.

NEW REW

The new **XXL-Size Bench** is a hybrid between a bench and sofa with tall legs and comfortable, easy to clean, one-piece cushions. The arm has also been set back to aid side entry.

The new **REW ROOM** can be used to partition a space into small "rooms". The compositions with sofas can be used to create private areas in bars and cafés, or informal meetings in offices, whereas the bench versions provide the perfect solution for restaurants. All without the need to resort to building works.

CARACTERISTIQUES

REW signifie rest-eat-work (se reposer-manger-travailler).

La versatile création de **Rafa García**. La signification littérale de ces mots définit à la perfection la fonctionnalité du programme REW.

Rest. Le repos est représenté par une famille de fauteuils, de canapés et de modules aussi légers que confortables, dans lesquels nous pourrions choisir entre 2 designs différents pour les bras : un aussi haut et étroit que le dossier et un autre plus bas et plus moelleux comme la base de l'assise.

Eat. La partie nutritive est composée par un grand choix de banquettes pour accompagner tout type de tables repas. Les banquettes sont disponibles en 2 profondeurs (57 et 72 centimètres). La profondeur la plus courte sert à obtenir une banquette plus traditionnelle et donne une assise plus ferme et droite. De plus la finition en angle des bras hauts permet de réaliser des compositions en angles droits. La profondeur la plus large a une dimension idéale pour être garnie de coussins de décoration et générer ainsi une assise plus informelle.

Work. La productivité au travail est en relation directe avec notre concentration et notre bien-être. La version des fauteuils, canapés et modules avec dossier haut permet de jouir d'un certain isolement au milieu d'un grand bureau ou dans un hall d'hôtel.

Rafa a aussi dessiné quelques coussins pour compléter le programme.

Les pieds sont en acier époxy noir et en frêne disponible dans toutes les teintes.

En option il est possible d'incorporer un kit de connexion USB-A+C et prise avec une grande amplitudes de fiches. Dans chaque référence du tarif les options disponibles son indiquées. La fiche de connexion au réseau électrique est définie par la prise internationale sélectionnée.

NOUVEAUTE REW

La nouveauté est la **banquette XXL**, qui se caractérise par le fait d'être à mi-chemin entre le banc et le canapé. Avec la hauteur d'assise d'une banquette mais avec un seul coussin aussi bien d'assise que de dossier, ce qui apporte un niveau de confort extra. De plus, le bras à été mis en retrait afin de faciliter l'accès.

Les **REW ROOM** arrivent lesquelles permettent de distribuer l'espace en créant des petites "pieces". Les compositions avec canapés servent aussi bien à créer des espaces réservés confortables dans des bars et cafés, comme des espaces de réunion informels dans des grands bureaux, tandis que les compositions avec banquettes sont la meilleure manière de configurer des espaces privés dans des restaurants. Et le tout sans nécessité de faire des travaux.

Sofá / Sofa / Canapé**Bancada / Bench / Banc**

FIRMEZA / FIRMNESS / FERMETÉ

FIRMEZA / FIRMNESS / FERMETÉ

SUAVE
SOFT
DOUX

FIRME
FIRM
FERME

SUAVE
SOFT
DOUX

FIRME
FIRM
FERME

IMPORTANTE

Las solicitudes de composiciones modulares deben adjuntar un plano en planta al realizar el pedido. La mano (derecha/izquierda) se interpreta siempre viendo el dibujo de frente.

Por favor, no olvide indicar en el pedido el tipo de acabado deseado para las patas.

Las patas requieren montaje. Consulte las instrucciones adjuntas al producto.

CARACTERISTICAS TECNICAS

TELA Y PIEL

- Estructura y almohadas totalmente desenfundables.
- Asiento: tubo de acero F1 pintado epoxi negro con tablero de partículas, recubierto de espuma CMHR 35kg y funda con velour.
- Respaldos y brazos altos: estructura de tablero de partículas, recubierto de espuma CMHR 30 kg y funda con velour, fijado mediante pletinas de acero F1 imprimado pintado epoxi negro.
- Brazo bajo: estructura de pino y tablero de partículas, recubierto de espuma CMHR 30kg y funda con velour, fijado mediante pletinas de acero F1 pintado epoxi negro.
- Patas: estructura de tubo de acero F1 pintado epoxi negro y recubiertas de madera de fresno.
- Almohada de respaldo: espuma de densidad diferenciada, recubierto de fibra poliéster H150 gr termofusionada y funda interior de malla.
- Almohada de respaldo: espuma de CM 25kg, recubierto de fibra poliéster H150 gr termofusionada y funda interior de malla.
- Cojines de decoración: funda de algodón rellena FiberDream (microfibra tacto pluma).
- Juego de placas metálicas para unir dos módulos.

Kit eléctrico:

- Longitud de cable: 2,5 metros.
- USB A + C 5A. (Carga rápida, si el dispositivo o terminal lo permite) En caso de rotura o avería, posibilidad de repuesto con cambio fácil, sin necesidad de desconectarlo de la toma eléctrica.
- Opción de enchufes internacionales.
- Montaje base enchufes con pestañas ocultas. Permite otra colocación a la sugerida.
- Carcasa de policarbonato negro retardante al fuego.
- Cúmple normativas: BS5733-2010 y IEC60884-1.
- Certificaciones: UL962A/CSA22.2
- Marcado CE: para las bases de las zonas "Gran Bretaña" y "Europa".
- Base enchufe GB: Incorpora fusible en cumplimiento de la normativa BS6396.

IMPORTANT

Modular compositions should be ordered with a plan view. Left/right are interpreted when looking at the front of the sofa.

Please remember to indicate the desired type of finish for the legs on the order.

The feet require fitting, as per the instructions that are included with the piece.

TECHNICAL CHARACTERISTICS

FABRIC AND LEATHER

- Removable back and cushion covers.
- Seat: black epoxy coated F1 steel covered in pressed wood covered in CMHR 35kg foam and fibre.
- High back and arms: pressed wood covered in CMHR 30kg foam with black epoxy coated F1 steel fittings.
- Low arm: solid wooden structure with a pressed wood board covered in CMHR 30kg foam and felt with black epoxy coated F1 steel fittings.
- Feet: black epoxy F1 steel covered in solid ash.
- Seat cushion: multi-density foam covered in H150g thermofused fibre and polyester netting.
- Back cushion: CM 25kg foam covered in H150g thermofused fibre and polyester netting.
- Scatter cushions: FiberDream with a cotton cover.
- Set of metallic plates to join two modules.

Electrical kit:

- Cable length: 2.5m.
- Fitted with USB A + C 5A (fast charge capable) easy to fix with a hot swap kit, sold separately.
- Range of international sockets available.
- Fire retardant black polycarbonate.
- Meets: BS5733-2010 and IEC60884-1.
- Certified by: UL962A/CSA22.2
- CE mark: for GB and Europe sockets.
- GB socket is fused as per BS6396.

IMPORTANT

Les commandes de compositions modulables doivent être accompagnées d'un plan avec les dessins toujours vue de face.

Ne pas oublier non plus d'indiquer le type de finition désiré pour les pieds.

Les pieds sont livrés démontés. Voir instructions de montage.

CARACTERISTIQUES TECHNIQUES

TISSU ET CUIR

- Structure et coussins 100% déhoussables.
- Assise: structure tubulaire en acier F1 peint époxy noir et panneau de particules, recouvert de mousse CMHR 35kg avec velours.
- Dossiers et bras haut: panneau de particules, recouvert de mousse CMHR 30kg avec velours, le tout fixé sur platine en acier F1 imprimé peint époxy noir.
- Bras bas: structure en pin et panneau de particules, recouvert de mousse CMHR 30kg avec velours, le tout fixé sur platine en acier F1 imprimé peint époxy noir.
- Pieds: structure tubulaire en acier F1 peint époxy noir et recouverte de bois de frêne.
- Coussins d'assise: mousses de différentes densités, recouvertes d'une fibre polyester H150gr et tissu de finition.
- Coussins de dos: mousse CM de 25kg, recouvertes d'une fibre polyester H150gr et tissu de finition.
- Coussins de décoration: housse coton garnie de fibre FiberDream (microfibre toucher plume).
- Jeu de plaques métalliques pour attacher deux modules.

Kit électrique :

- Longueur du câble: 2.5 mètres
- USB + C5A (charge rapide). En cas de casse ou de panne, possibilité de réparation avec échange facile, sans déconnexion de la prise de courant.
- Option prises de courant internationales.
- Montage base-prise avec des attaches ocultes. Permet d'autres choix d'installation que celui proposé.
- Boîtier en polycarbonate noir feu retardant.
- Conforme aux normes : BS5733-2010 et IEC60884-1.
- Certifications: UL962A/CSA22.2
- Marquage CE: pour les bases des zones « Grande Bretagne » et « Europe ».
- Base prise GB: incorpore fusible selon la norme BS6396.

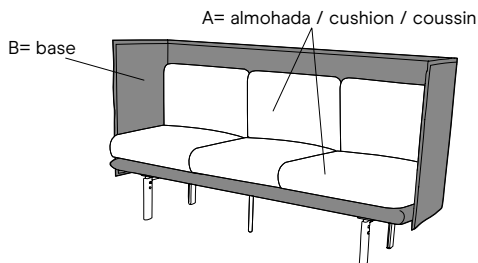

ACABADOS / FINISHES / FINITIONS

PATAS / FEET / PIED

FRESNO / ASH / FRESNE
TINTES / STAINS / TEINTES



ALTURA RESPALDOS
BACK HEIGHTS
HAUTEUR DOSSIER

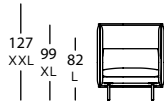

Sofás
Sofas
Canapés

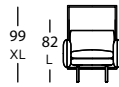

Sofás Brazo Bajo
Low Armed Sofas
Canapés Bras Bas

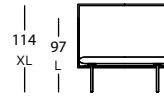

Bancadas
Benches
Banc

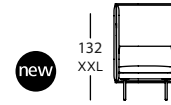

new

Bancadas
Benches
Banc

FONDO
DEPTH
PROFONDEUR



Sofás
Sofas
Canapés



Bancadas
Benches
Banc

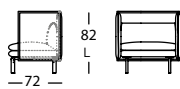

Sofás L
L Sofas
Canapés L

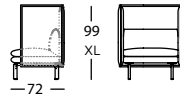

Sofás XL
XL Sofas
Canapés XL

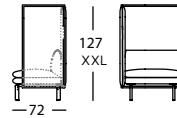

Sofás XXL
XXL Sofas
Canapés XXL

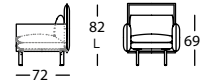

Sofás L Brazo bajo
Low Armed L Sofas
Canapés L Bras Bas

FAMILIA
FAMILY
FAMILLE

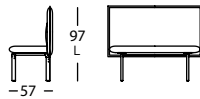

Bancadas L Fondo 57
L Shallow benches
Banc L Profondeur 57



Brazo L Fondo 57
L Shallow arm
Bras L Profondeur 57

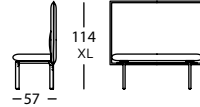

Bancadas XL Fondo 57
XL Shallow benches
Banc XL Profondeur 57

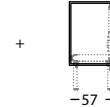

XL Fondo 57
XL Shallow arm Brazo
Bras XL Profondeur 57

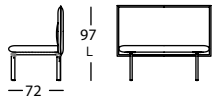

Bancadas L Fondo 72
L Deep benches
Banc L Profondeur 72



Brazo Bajo
Low arm
Bras bas



Brazo L Fondo 57
L Shallow arm
Bras L Profon. 57



Brazo L Fondo 72
L Deep arm
Bras L Profon. 72

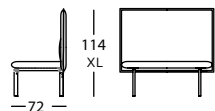

Bancadas XL Fondo 72
XL Deep benches
Banc XL Profondeur 72



Brazo Bajo
Low arm
Bras bas



Brazo XL Fondo 57
XL Shallow arm
Bras XL Profon. 57



Brazo XL Fondo 72
XL Deep arm
Bras XL Profon. 72

new

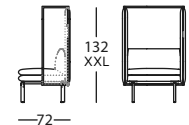

Bancadas XXL Fondo 72
XXL Deep benches
Banc XXL Profondeur 72

KIT ELÉCTRICO
ELECTRIC SET
KIT ÉLECTRIQUE

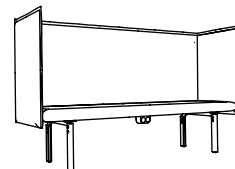
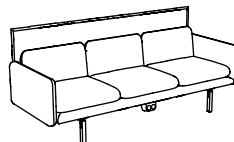
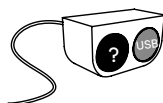

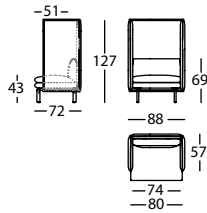
REW by Rafa García, 2014Respaldos y brazos altura XXLXXL-size backs & arms / Dos et bras hauteur XXL**292.11.JN.2**

REW SILLON 88 XXL
REW XXL-SIZE ARMCHAIR 88
REW FAUTEUIL 88 XXL

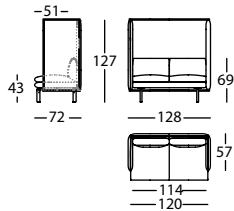
0,76 m³ / 1 Pack. / 54,5 kg**292.11.NN.2**

REW SOFA 128 XXL
REW XXL-SIZE SOFA 128
REW CANAPE 128 XXL

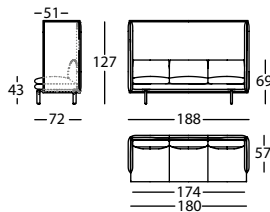
1,10 m³ / 1 Pack. / 64,0 kg**292.11.UN.2**

REW SOFA 188 XXL
REW XXL-SIZE SOFA 188
REW CANAPE 188 XXL

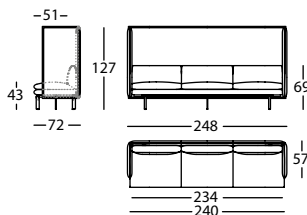
1,60 m³ / 1 Pack. / 78,0 kg**292.11.Z1N.2**

REW SOFA 248 XXL
REW XXL-SIZE SOFA 248
REW CANAPE 248 XXL

2,10 m³ / 1 Pack. / 92,0 kg

new

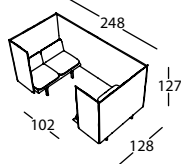
**292.11.Z1N**

REW ROOM SOFA 248X128 XXL
REW XXL-SIZE ROOM SOFA 248X128
REW ROOM CANAPE 248X128 XXL

1,82 m³ / 3 Pack. / 130,4 kg

new

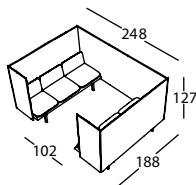
**292.11.Z1U**

REW ROOM SOFA 248X188 XXL
REW XXL-SIZE ROOM SOFA 248X188
REW ROOM CANAPE 248X188 XXL

2,57 m³ / 3 Pack. / 161,7 kg

new

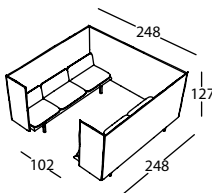
**292.11.Z1Z1**

REW ROOM SOFA 248X248 XXL
REW XXL-SIZE ROOM SOFA 248X248
REW ROOM CANAPE 248X248 XXL

3,32 m³ / 3 Pack. / 206,3 kg

REW by Rafa García, 2014



Bancadas fondo 72 altura XXL / Shallow benches, XXL-size backs & arms / Banc profondeur 72 hauteur XXL

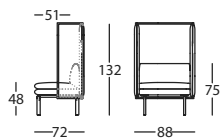

new



292.12.JHP

REW BANCADA 88 XXL
REW XXL-SIZE BENCH 88
REW BANC 88 XXL

0,76 m³ / 1 Pack. / 54,5 kg

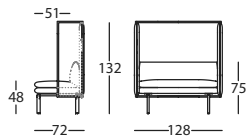

new

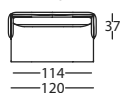

292.12.NHP

REW BANCADA128 XXL
REW XXL-SIZE BENCH 128
REW BANC 128 XXL

1,10 m³ / 1 Pack. / 64,0 kg

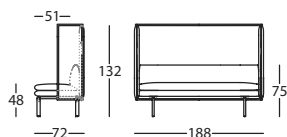

new

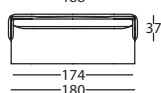

292.12.UHP

REW BANCADA 188 XXL
REW XXL-SIZE BENCH 188
REW BANC 188 XXL

1,60 m³ / 1 Pack. / 78,0 kg

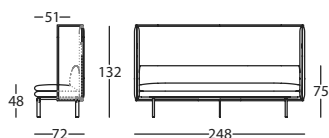

new

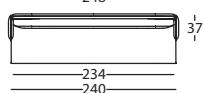

292.12.Z1HP

REW BANCADA 248 XXL
REW XXL-SIZE BENCH 248
REW BANC 248 XXL

2,10 m³ / 1 Pack. / 92,0 kg

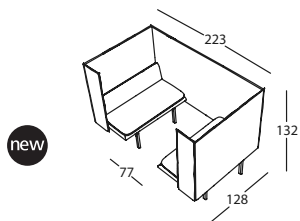

new

292.11.YNP

REW ROOM BANCADA 223X128 XXL
REW XXL-SIZE ROOM BENCH 223X128
REW ROOM BANC 223X128 XXL

1,79 m³ / 3 Pack. / 130,4 kg

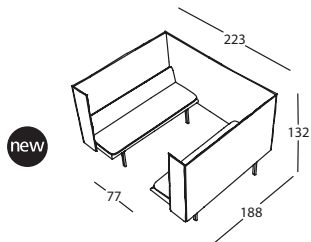

new

292.11.YUP

REW ROOM BANCADA 223X188 XXL
REW XXL-SIZE ROOM BENCH 223X188
REW ROOM BANC 223X188 XXL

2,54 m³ / 3 Pack. / 161,7 kg

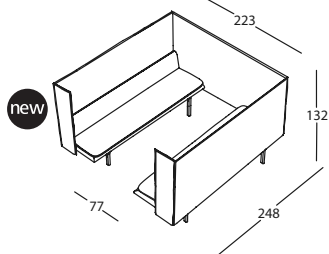

new

292.11.YZ1P

REW ROOM SOFÁ BANCADA 223X248 XXL
REW XXL-SIZE ROOM BENCH 223X248
REW ROOM BANC 223X248 XXL

3,29 m³ / 3 Pack. / 206,3 kg

REW by Rafa García, 2014

Sistema de asientos para descansar, comer o trabajar / Sofa system for Resting, Eating or Working / Canape pour se reposer, manger ou travailler

Composiciones recomendadas
Recommended compositions
Compositions recommandables

REW ROOM BANCADA / BENCH / BANC	DUMBBELL MESA / TABLE
------------------------------------	--------------------------

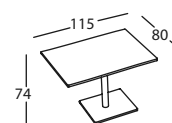
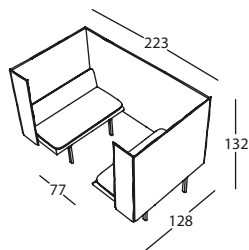
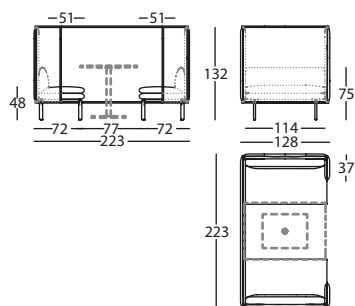

292.11.YNP

REW ROOM BANCADA 223X128 XXL
REW XXL-SIZE ROOM BENCH 223X128
REW ROOM BANC 223X128 XXL

1,79 m³ / 3 Pack. / 130,4 kg

318.74.115X80X74

DUMBBELL MESA COMEDOR 115X80X74
DUMBBELL DINING TABLE 115X80X74
DUMBBELL TABLE REPAS 115X80X74

0,13 m³ / 3 Pack. / 33,5 kg

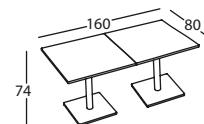
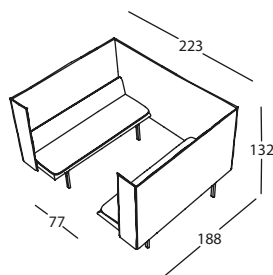
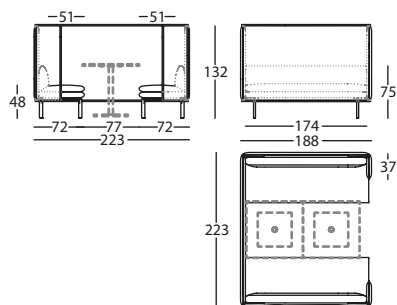

292.11.YUP

REW ROOM BANCADA 223X188 XXL
REW XXL-SIZE ROOM BENCH 223X188
REW ROOM BANC 223X188 XXL

2,54 m³ / 3 Pack. / 161,7 kg

318.74.80X74 x2

DUMBBELL MESA COMEDOR 80X80X74
DUMBBELL DINING TABLE 80X80X74
DUMBBELL TABLE REPAS 80X80X74

0,10 m³ / 3 Pack. / 28,4 kg

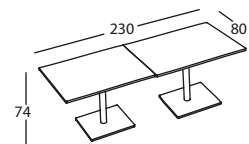
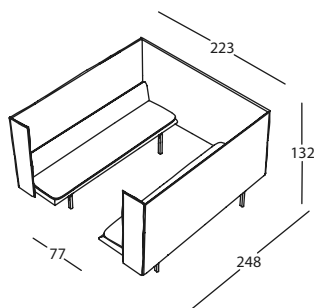
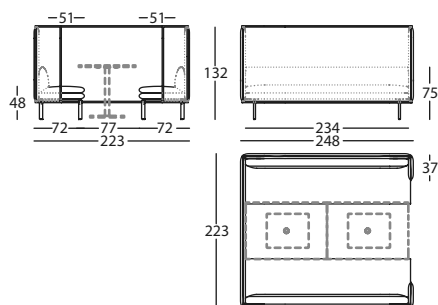

292.11.YZ1P

REW ROOM SOFÁ BANCADA 223X248 XXL
REW XXL-SIZE ROOM BENCH 223X248
REW ROOM BANC 223X248 XXL

3,29 m³ / 3 Pack. / 206,3 kg

318.74.115X80X74 x2

DUMBBELL MESA COMEDOR 115X80X74
DUMBBELL DINING TABLE 115X80X74
DUMBBELL TABLE REPAS 115X80X74

0,13 m³ / 3 Pack. / 33,5 kg

REW by Rafa García, 2014



Respaldos y brazos altura L

L-size backs & arms / Dos et bras hauteur L

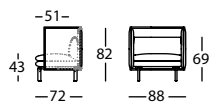
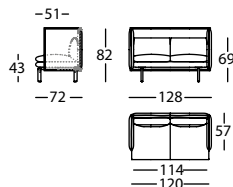
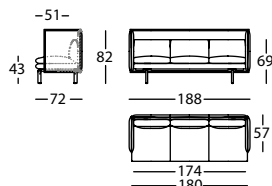
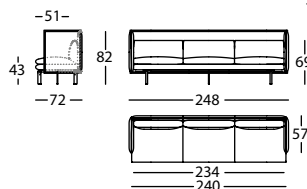
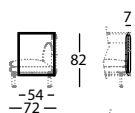
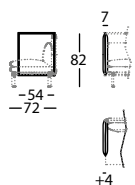
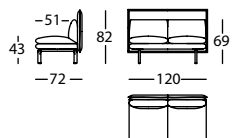
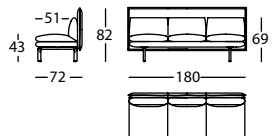
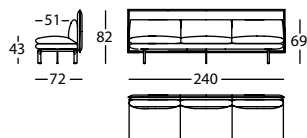
**292.11.JJ.2**REW SILLON 88 L
REW L-SIZE ARMCHAIR 88
REW FAUTEUIL 88 L0,46 m³ / 1 Pack. / 38,0 kg**292.11.NJ.2**REW SOFA 128 L
REW L-SIZE SOFA 128
REW CANAPE 128 L0,66 m³ / 1 Pack. / 48,0 kg**292.11.UJ.2**REW SOFA 188 L
REW L-SIZE SOFA 188
REW CANAPE 188 L0,96 m³ / 1 Pack. / 63,5 kg**292.11.Z1J.2**REW SOFA 248 L
REW L-SIZE SOFA 248
REW CANAPE 248 L1,25 m³ / 1 Pack. / 81,0 kg**292.133.J.D**REW BRAZO L DCHO
REW L-SIZE RIGHT ARM
REW BRAS L DROIT0,02 m³ / - Pack. / 6,0 kg**292.133.J.I**REW BRAZO L IZDO
REW L-SIZE LEFT ARM
REW BRAS L GAUCHE0,02 m³ / - Pack. / 6,0 kg**292.12.NJ**REW MOD 120 L
REW L-SIZE MODULE 120
REW MODULE 120 L0,62 m³ / 1 Pack. / 36,0 kg**292.12.UJ**REW MOD 180 L
REW L-SIZE MODULE 180
REW MODULE 180 L0,92 m³ / 1 Pack. / 51,5 kg**292.12.Z1J**REW MOD 240 L
REW L-SIZE MODULE 240
REW MODULE 240 L1,21 m³ / 1 Pack. / 69,0 kg

Cada uno de los brazos incluidos en esta página sólo se puede combinar con los 3 módulos referenciados a continuación de los mismos.

Each one of the arms presented on this page can only be combined with the three modules listed below them.

Chacun des bras figurant sur cette page ne peut être combiné qu'avec les 3 modules se trouvant en dessous.

----- LINEAS OCULTAS / HIDDEN LINES / LIGNES OCCULTES

REW by Rafa García, 2014

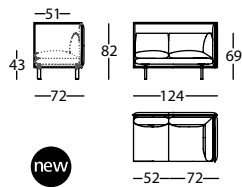

292.16.NJ.D

REW ANGULO DCHO 124 L
REW L-SIZE RIGHT CORNER 124
REW ANGLE DROIT 124 L

0,64 m³ / 1 Pack. / 45,0 kg

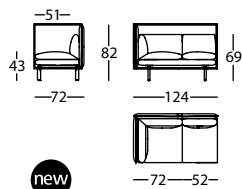

292.16.NJ.I

REW ANGULO IZDO 124 L
REW L-SIZE LEFT CORNER 124
REW ANGLE GAUCHE 124 L

0,64 m³ / 1 Pack. / 45,0 kg

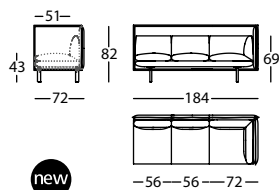

292.16.UJ.D

REW ANGULO DCHO 184 L
REW L-SIZE RIGHT CORNER 184
REW ANGLE DROIT 184 L

0,94 m³ / 1 Pack. / 61,9 kg

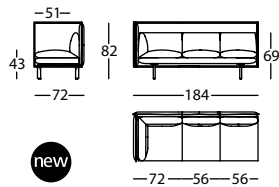

292.16.UJ.I

REW ANGULO IZDO 184 L
REW L-SIZE LEFT CORNER 184
REW ANGLE GAUCHE 184 L

0,94 m³ / 1 Pack. / 61,9 kg

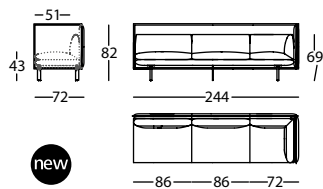

292.16.Z1J.D

REW ANGULO DCHO 244 L
REW L-SIZE RIGHT CORNER 244
REW ANGLE DROIT 244 L

1,23 m³ / 1 Pack. / 80,5 kg

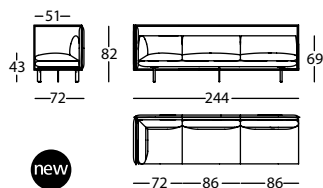

292.16.Z1J.I

REW ANGULO IZDO 244 L
REW L-SIZE LEFT CORNER 244
REW ANGLE GAUCHE 244 L

1,23 m³ / 1 Pack. / 80,5 kg

EJEMPLO ANGULOS / EXAMPLE CORNER / EXEMPLE ANGLE

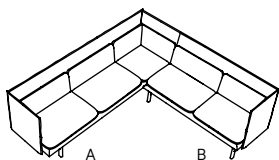

REF MOD:

A
292.16.UJ.D
REW ANGULO DCHO 184 L
REW L-SIZE RIGHT CORNER 184
REW ANGLE DROIT 184 L

B
292.133.J.I
REW BRAZO L IZDO
REW L-SIZE LEFT ARM
REW BRAS L GAUCHE

B
292.12.NJ
REW MOD 120 L
REW L-SIZE MODULE 120
REW MODULE 120 L

B
292.133.J.D
REW BRAZO L DCHO
REW L-SIZE RIGHT ARM
REW BRAS L DROIT

* REF MOD:

A
292.16.UJ.D
REW ANGULO DCHO 184 L
REW L-SIZE RIGHT CORNER 184
REW ANGLE DROIT 184 L

B
292.133.J.I
REW BRAZO L IZDO
REW L-SIZE LEFTARM
REW BRAS L GAUCHE

B
292.12.NJ
REW MOD 120 L
REW L-SIZE MODULE 120
REW MODULE 120 L

B
292.134.J.I
REW BRAZO BAJO DCHO
REW LOW RIGHT ARM
REW BRAS BAS DROIT

* Válidos también para Rew L brazo bajo. / Valid for L-size Rew low arm. / Valable pour Rew L bras bas.

REW by Rafa García, 2014

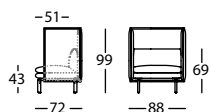

Respaldos y brazos altura XL
XL-size backs & arms / Dos et bras hauteur XL

**292.11.JK.2**

REW SILLON 88 XL
REW XL-SIZE ARMCHAIR 88
REW FAUTEUIL 88 XL

0,57 m³ / 1 Pack. / 44,5 kg**292.11.NK.2**

REW SOFA 128 XL
REW XL-SIZE SOFA 128
REW CANAPE 128 XL

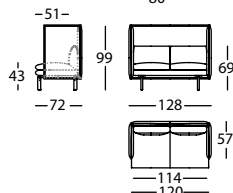
0,82 m³ / 1 Pack. / 54,0 kg**292.11.UK.2**

REW SOFA 188 XL
REW XL-SIZE SOFA 188
REW CANAPE 188 XL

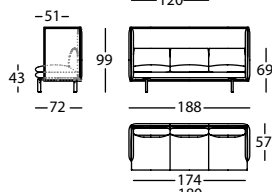
1,20 m³ / 1 Pack. / 68,0 kg**292.11.Z1K.2**

REW SOFA 248 XL
REW XL-SIZE SOFA 248
REW CANAPE 248 XL

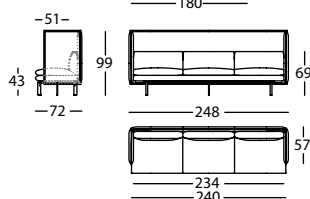
1,58 m³ / 1 Pack. / 89,0 kg**292.133.K.D**

REW BRAZO XL DCHO
REW XL-SIZE RIGHT ARM
REW BRAS XL DROIT

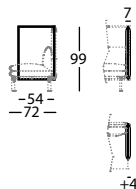
0,02 m³ / - Pack. / 8,0 kg**292.133.K.I**

REW BRAZO XL IZDO
REW XL-SIZE LEFT ARM
REW BRAS XL GAUCHE

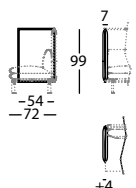
0,02 m³ / - Pack. / 8,0 kg**292.12.NK**

REW MOD 120 XL
REW XL-SIZE MODULE 120
REW MODULE 120 XL

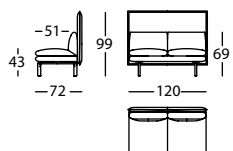
0,77 m³ / 1 Pack. / 38,0 kg**292.12.UK**

REW MOD 180 XL
XL-SIZE MODULE 180
MODULE 180 XL

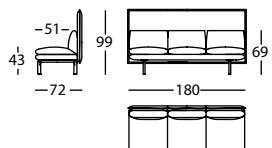
1,15 m³ / 1 Pack. / 52,0 kg**292.12.Z1K**

REW MOD 240 XL
REW XL-SIZE MODULE 240
REW MODULE 240 XL

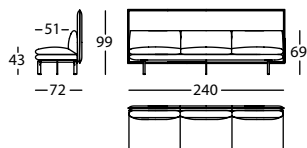
1,53 m³ / 1 Pack. / 73,0 kg

Cada uno de los brazos incluidos en esta página sólo se puede combinar con los 3 módulos referenciados a continuación de los mismos.
Each one of the arms presented on this page can only be combined with the three modules listed below them.
Chacun des bras figurant sur cette page ne peut être combiné qu'avec les 3 modules se trouvant en dessous.

----- LINEAS OCULTAS / HIDDEN LINES / LIGNES OCCULTES

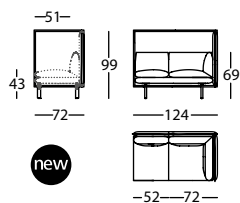

292.16.NK.D

REW ANGULO DCHO 124 XL
REW XL-SIZE RIGHT CORNER 124
REW ANGLE DROIT 124 XL

0,80 m³ / 1 Pack. / 49,5 kg

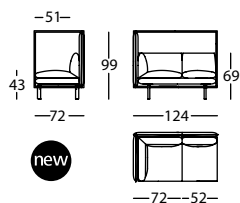

292.16.NK.I

REW ANGULO IZDO 124 XL
REW XL-SIZE LEFT CORNER 124
REW ANGLE GAUCHE 124 XL

0,80 m³ / 1 Pack. / 49,5 kg

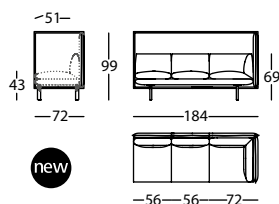

292.16.UK.D

REW ANGULO DCHO 184 XL
REW XL-SIZE RIGHT CORNER 184
REW ANGLE DROIT 184 XL

1,17 m³ / 1 Pack. / 65,2 kg

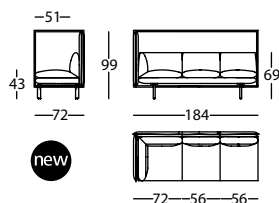

292.16.UK.I

REW ANGULO IZDO 184 XL
REW XL-SIZE LEFT CORNER 184
REW ANGLE GAUCHE 184 XL

1,17 m³ / 1 Pack. / 65,2 kg

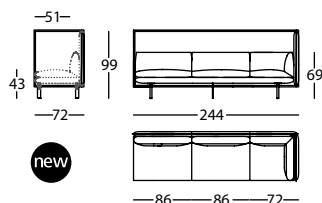

292.16.Z1K.D

REW ANGULO DCHO 244 XL
REW XL-SIZE RIGHT CORNER 244
REW ANGLE DROIT 244 XL

1,55 m³ / 1 Pack. / 87,5 kg

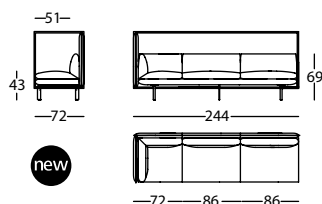

292.16.Z1K.I

REW ANGULO IZDO 244 XL
REW XL-SIZE LEFT CORNER 244
REW ANGLE GAUCHE 244 XL

1,55 m³ / 1 Pack. / 87,5 kg

EJEMPLO ANGULOS / EXAMPLE CORNER / EXEMPLE ANGLE

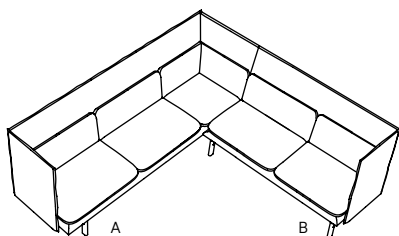

REF MOD:

A
292.16.UK.D
REW ANGULO DCHO 184 XL
REW XL-SIZE RIGHT CORNER 184
REW ANGLE DROIT 184 XL

+
292.133.K.I
REW BRAZO XL IZDO
REW XL-SIZE LEFT ARM
REW BRAS XL GAUCHE

B
292.12.NK
REW MOD 120 XL
REW XL-SIZE MODULE 120
REW MODULE 120 XL

+
292.133.K.D
REW BRAZO XL DCHO
REW XL-SIZE RIGHT ARM
REW BRAS XL DROIT

REW by Rafa García, 2014

Respaldos altura L con brazo bajo

L-size backs with low arms / Dos hauteur L avec bras bas

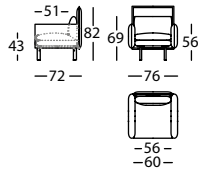
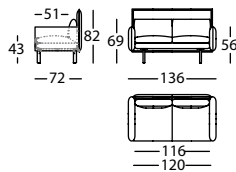
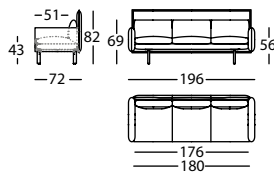
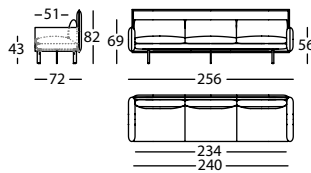
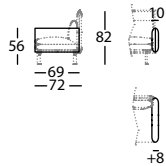
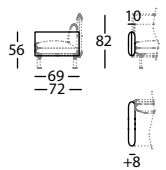
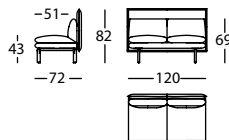
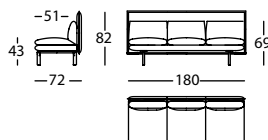
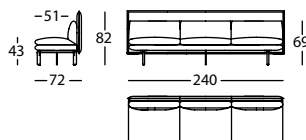
**292.11.HJ.1**REW SILLON 76 L BR BAJO
REW L-SIZE ARMCHAIR 76 LOW ARM
REW FAUTEUIL 76 L BRAS BAS0,38 m³ / 1 Pack. / 32,5 kg**292.11.PJ.1**REW SOFA 136 L BR BAJO
REW L-SIZE SOFA 136 LOW ARM
REW CANAPE 136 L BRAS BAS0,69 m³ / 1 Pack. / 48,0 kg**292.11.VJ.1**REW SOFA 196 L BR BAJO
REW L-SIZE SOFA 196 LOW ARM
REW CANAPE 196 L BRAS BAS0,99 m³ / 1 Pack. / 63,5 kg**292.11.Z2J.1**REW SOFA 256 L BR BAJO
REW L-SIZE SOFA 256 LOW ARM
REW CANAPE 256 L BRAS BAS1,28 m³ / 1 Pack. / 81,0 kg**292.134.J.D**REW BRAZO BAJO DCHO
REW LOW RIGHT ARM
REW BRAS BAS DROIT0,04 m³ / - Pack. / 6,0 kg**292.134.J.I**REW BRAZO BAJO IZDO
REW LOW LEFT ARM
REW BRAS BAS GAUCHE0,04 m³ / - Pack. / 6,0 kg**292.12.NJ**REW MOD 120 L
REW L-SIZE MODULE 120
REW MODULE 120 L0,62 m³ / 1 Pack. / 36,0 kg**292.12.UJ**REW MOD 180 L
REW L-SIZE MODULE 180
REW MODULE 180 L0,92 m³ / 1 Pack. / 51,5 kg**292.12.Z1J**REW MOD 240 L
REW L-SIZE MODULE 240
REW MODULE 240 L1,21 m³ / 1 Pack. / 69,0 kg

Cada uno de los brazos incluidos en esta página sólo se puede combinar con los 3 módulos referenciados a continuación de los mismos.

Each one of the arms presented on this page can only be combined with the three modules listed below them.

Chacun des bras figurant sur cette page ne peut être combiné qu'avec les 3 modules se trouvant en dessous.

----- LINEAS OCULTAS / HIDDEN LINES / LIGNES OCCULTES

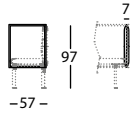
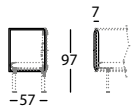
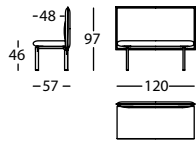
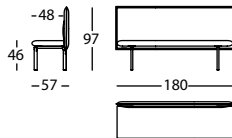
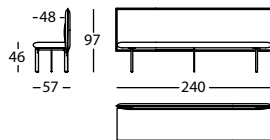
REW by Rafa García, 2014Bancadas fondo 57 altura L / Shallow benches, L-size
backs & arms / Banc profondeur 57 hauteur L**292.133.FK.D**REW BRAZO L FONDO 57 DCHO
REW L-SIZE SHALLOW RIGHT ARM
REW BRAS L PROFONDEUR 57 DROIT0,02 m³ / - Pack. / 6,0 kg**292.133.FK.I**REW BRAZO L FONDO 57 IZDO
REW L-SIZE SHALLOW LEFT ARM
REW BRAS L PROFONDEUR 57 GAUCHE0,02 m³ / - Pack. / 6,0 kg**292.12.NFK**REW BANCADA 120 L FONDO 57
REW L-SIZE SHALLOW BENCH 120
REW BANC 120 L PROFONDEUR 570,49 m³ / 1 Pack. / 25,0 kg**292.12.UFK**REW BANCADA 180 L FONDO 57
REW L-SIZE SHALLOW BENCH 180
REW BANC 180 L PROFONDEUR 570,73 m³ / 1 Pack. / 36,0 kg**292.12.Z1FK**REW BANCADA 240 L FONDO 57
REW L-SIZE SHALLOW BENCH 240
REW BANC 240 L PROFONDEUR 570,97 m³ / 1 Pack. / 48,5 kg

Cada uno de los brazos incluidos en esta página sólo se puede combinar con los 3 módulos referenciados a continuación de los mismos.

Each one of the arms presented on this page can only be combined with the three modules listed below them.

Chacun des bras figurant sur cette page ne peut être combiné qu'avec les 3 modules se trouvant en dessous.

..... LINEAS OCULTAS / HIDDEN LINES / LIGNES OCCULTES

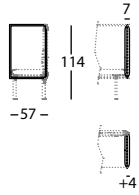
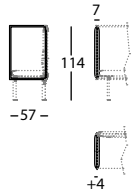
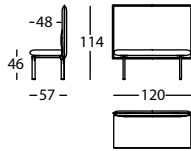
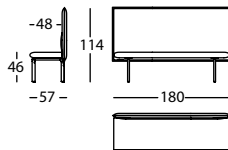
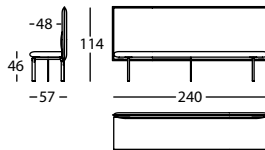
REW by Rafa García, 2014Bancadas fondo 57 altura XL / Shallow benches, XL-size
backs & arms / Banc profondeur 57 hauteur XL**292.133.FM.D**REW BRAZO XL FONDO 57 DCHO
REW XL-SIZE SHALLOW RIGHT ARM
REW BRAS XL PROFONDEUR 57 DROIT0,02 m³ / - Pack. / 8,0 kg**292.133.FM.I**REW BRAZO XL FONDO 57 IZDO
REW XL-SIZE SHALLOW LEFT ARM
REW BRAS XL PROFONDEUR 57 GAUCHE0,02 m³ / - Pack. / 8,0 kg**292.12.NFM**REW BANCADA 120 XL FONDO 57
REW XL-SIZE SHALLOW BENCH 120
REW BANC 120 XL PROFONDEUR 570,62 m³ / 1 Pack. / 41,5 kg**292.12.UFM**REW BANCADA 180 XL FONDO 57
REW XL-SIZE SHALLOW BENCH 180
REW BANC 180 XL PROFONDEUR 570,92 m³ / 1 Pack. / 60,0 kg**292.12.Z1FM**REW BANCADA 240 XL FONDO 57
REW XL-SIZE SHALLOW BENCH 240
REW BANC 240 XL PROFONDEUR 571,22 m³ / 1 Pack. / 80,0 kg

REW by Rafa García, 2014

Bancadas fondo 72 altura L / Deep benches, L-size
backs & arms / Banc profondeur 72 hauteur L

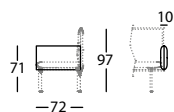
**292.134.J.D**

REW BRAZO BAJO DCHO
REW LOW RIGHT ARM
REW BRAS BAS DROIT

0,04 m³ / - Pack. / 6,0 kg**292.134.J.I**

REW BRAZO BAJO IZDO
REW LOW LEFT ARM
REW BRAS BAS GAUCHE

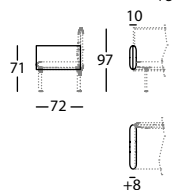
0,04 m³ / - Pack. / 6,0 kg**292.133.FK.D**

REW BRAZO L FONDO 57 DCHO
REW L-SIZE SHALLOW RIGHT ARM
REW BRAS L PROFONDEUR 57 DROIT

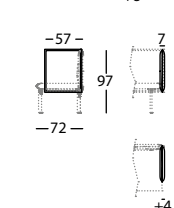
0,02 m³ / - Pack. / 6,0 kg**292.133.FK.I**

REW BRAZO L FONDO 57 IZDO
REW L-SIZE SHALLOW LEFT ARM
REW BRAS L PROFONDEUR 57 GAUCHE

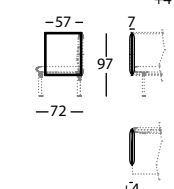
0,02 m³ / - Pack. / 6,0 kg**292.133.HK.D**

REW BRAZO L FONDO 72 DCHO
REW L-SIZE DEEP RIGHT ARM
REW BRAS L PROFONDEUR 72 DROIT

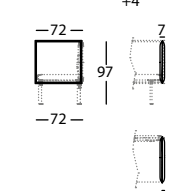
0,02 m³ / - Pack. / 6,0 kg**292.133.HK.I**

REW BRAZO L FONDO 72 IZDO
REW L-SIZE DEEP LEFT ARM
REW BRAS L PROFONDEUR 72 GAUCHE

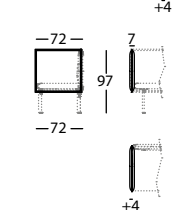
0,02 m³ / - Pack. / 6,0 kg**292.12.NHK**

REW BANCADA 120 L FONDO 72
REW L-SIZE DEEP BENCH 120
REW BANC 120 L PROFONDEUR 72

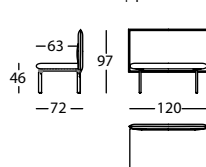
0,62 m³ / 1 Pack. / 31,0 kg**292.12.UHK**

REW BANCADA 180 L FONDO 72
REW L-SIZE DEEP BENCH 180
REW BANC 180 L PROFONDEUR 72

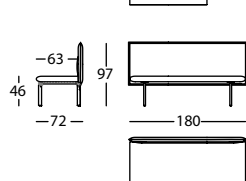
0,92 m³ / 1 Pack. / 44,0 kg**292.12.Z1HK**

REW BANCADA 240 L FONDO 72
REW L-SIZE DEEP BENCH 240
REW BANC 240 L PROFONDEUR 72

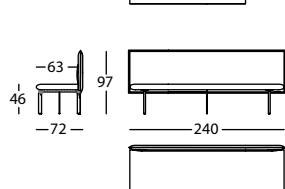
1,21 m³ / 1 Pack. / 58,5 kg

Cada uno de los brazos incluidos en esta página sólo se puede combinar con los 3 módulos referenciados a continuación de los mismos.

Each one of the arms presented on this page can only be combined with the three modules listed below them.

Chacun des bras figurant sur cette page ne peut être combiné qu'avec les 3 modules se trouvant en dessous.

----- LINEAS OCULTAS / HIDDEN LINES / LIGNES OCCULTES

REW by Rafa García, 2014

Bancadas fondo 72 altura XL / Deep benches, XL-size
backs & arms / Banc profondeur 72 hauteur XL

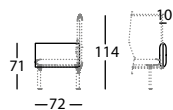
**292.134.JD**

REW BRAZO BAJO DCHO
 REW LOW RIGHT ARM
 REW BRAS BAS DROIT

0,04 m³ / - Pack. / 6,0 kg**292.134.JI**

REW BRAZO BAJO IZDO
 REW LOW LEFT ARM
 REW BRAS BAS GAUCHE

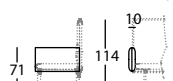
0,04 m³ / - Pack. / 6,0 kg**292.133.FM.D**

REW BRAZO XL FONDO 57 DCHO
 REW XL-SIZE SHALLOW RIGHT ARM
 REW BRAS XL PROFONDEUR 57 DROIT

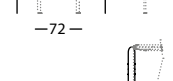
0,02 m³ / - Pack. / 8,0 kg**292.133.FM.I**

REW BRAZO XL FONDO 57 IZDO
 REW XL-SIZE SHALLOW LEFT ARM
 REW BRAS XL PROFONDEUR 57 GAUCHE

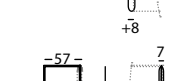
0,02 m³ / - Pack. / 8,0 kg**292.133.HM.D**

REW BRAZO XL FONDO 72 DCHO
 REW XL-SIZE DEEP RIGHT ARM
 REW BRAS XL PROFONDEUR 72 DROIT

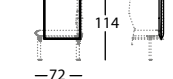
0,02 m³ / - Pack. / 8,0 kg**292.133.HM.I**

REW BRAZO XL FONDO 72 IZDO
 REW XL-SIZE DEEP LEFT ARM
 REW BRAS XL PROFONDEUR 72 GAUCHE

0,02 m³ / - Pack. / 8,0 kg**292.12.NHM**

REW BANCADA 120 XL FONDO 72
 REW XL-SIZE DEEP BENCH 120
 REW BANC 120 XL PROFONDEUR 72

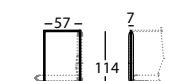
0,77 m³ / 1 Pack. / 33,0 kg**292.12.UHM**

REW BANCADA 180 XL FONDO 72
 REW XL-SIZE DEEP BENCH 180
 REW BANC 180 XL PROFONDEUR 72

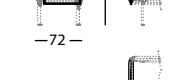
1,15 m³ / 1 Pack. / 44,5 kg**292.12.Z1HM**

REW BANCADA 240 XL FONDO 72
 REW XL-SIZE DEEP BENCH 240
 REW BANC 240 XL PROFONDEUR 72

1,53 m³ / 1 Pack. / 62,5 kg

Cada uno de los brazos incluidos en esta página sólo se puede combinar con los 3 módulos referenciados a continuación de los mismos.

Each one of the arms presented on this page can only be combined with the three modules listed below them.

Chacun des bras figurant sur cette page ne peut être combiné qu'avec les 3 modules se trouvant en dessous.

----- LINEAS OCULTAS / HIDDEN LINES / LIGNES OCCULTES

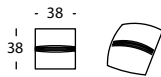
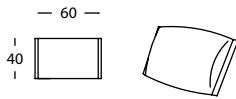
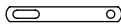
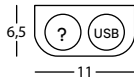
REW by Rafa García, 2014Accesorios / Accesories / Accessoires**292.22.DD**REW COJIN 38X38
REW CUSHION 38X38
REW COUSSIN 38X380,02 m³ / - Pack. / 0,7 kg**292.22.GE**REW ALMOHADA 60X40
REW CUSHION 60X40
REW COUSSIN 60X400,04 m³ / - Pack. / 1,7 kg**292.31**REW JUEGO PLACAS UNION MODULO
SET OF METAL COUPLERS FOR JOINING MODULES
REW JEU DE PLAQUES D'UNION POUR MODULES- m³ / - Pack. / - kg**292.2H.MIX**KIT ELECTRICO MIXTO 1 BASE ENCHUFE + 1 USB
MIXED ELECTRIC SET 1 PLUG BASE + 1 USB
KIT ÉLECTRIQUE MIXTE 1 PRISE + 1 USB0,01 m³ / - Pack. / 1,52 kg

REW by Rafa García, 2014

Sistema de asientos para descansar, comer o trabajar / Sofa system for Resting, Eating or Working / Canape pour se reposer, manger ou travailler

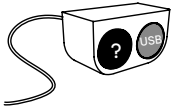

FÁCIL MONTAJE / EASY ASSEMBLY / MONTAGE FACILE

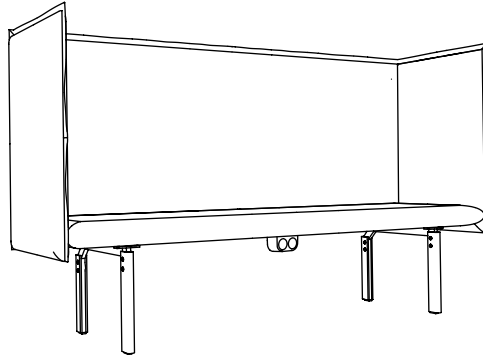
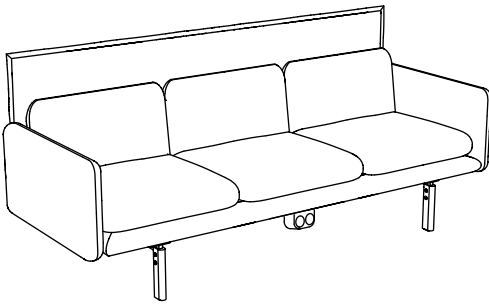

KIT ELÉCTRICO OPCIONAL / OPTIONAL ELECTRICAL KIT / KIT ÉLECTRIQUE EN OPTION



SELECCIONE EL ENCHUFE / SELECT AC SOCKET / SÉLECTIONNE LE PRISE

USB A + C 5A



EU



AU



GB



US/JP*



* No disponemos de certificación para Japón / Does not meet Japanese certification / Ne répond pas à la certification du Japon.

Se suministrará el kit eléctrico con USB-A+C. Seleccione el enchufe internacional entre los cuatro tipos que se ilustran en el cuadro superior. La clavija de conexión a la red eléctrica viene definida por el enchufe internacional.

The electrical kit comes with USB-A+C. Choose the remaining AC socket for your country from the four types illustrated above. The plug will be the same type as the AC socket.

Le kit électrique est livré avec USB – A+C. Sélectionner la prise internationale qui vous convient entre les 4 types proposés, illustrés dans le cadre supérieur. La fiche de connexion au réseau électrique est définie par la prise internationale.

GB Socket: Fusing to enable compliance to BS6396.

Compliant with: BS5733-2010 and IEC60884-1

Certifications: UL962A/CSA22.2

CE marking: All units built with UK and European socket types are CE marked